

SS4000 Series

SS4013MG-12M-WGN01E



Features

- High-performance AI processing chips with multi-core parallel processing capabilities to realize complex image processing;
- Built-in rich algorithm tools for object positioning, feature recognition, defect inspection, edge learning-based classification, and more;
- Compact design with rotatable rear connectors, suitable for narrow spaces;
- Integrated design with built-in auto focus lens and multiple type multiple channel light sources, with super environmental adaptability;
- Powerful image processing algorithms with simple and efficient one-click configuration;
- Cross-platform Web access and guided configuration process, flexible for tuning and deployment;
- Abundant IO interfaces such as Ethernet, RS232, and GPIO, support multiple communication protocols.

Dimensions (mm)

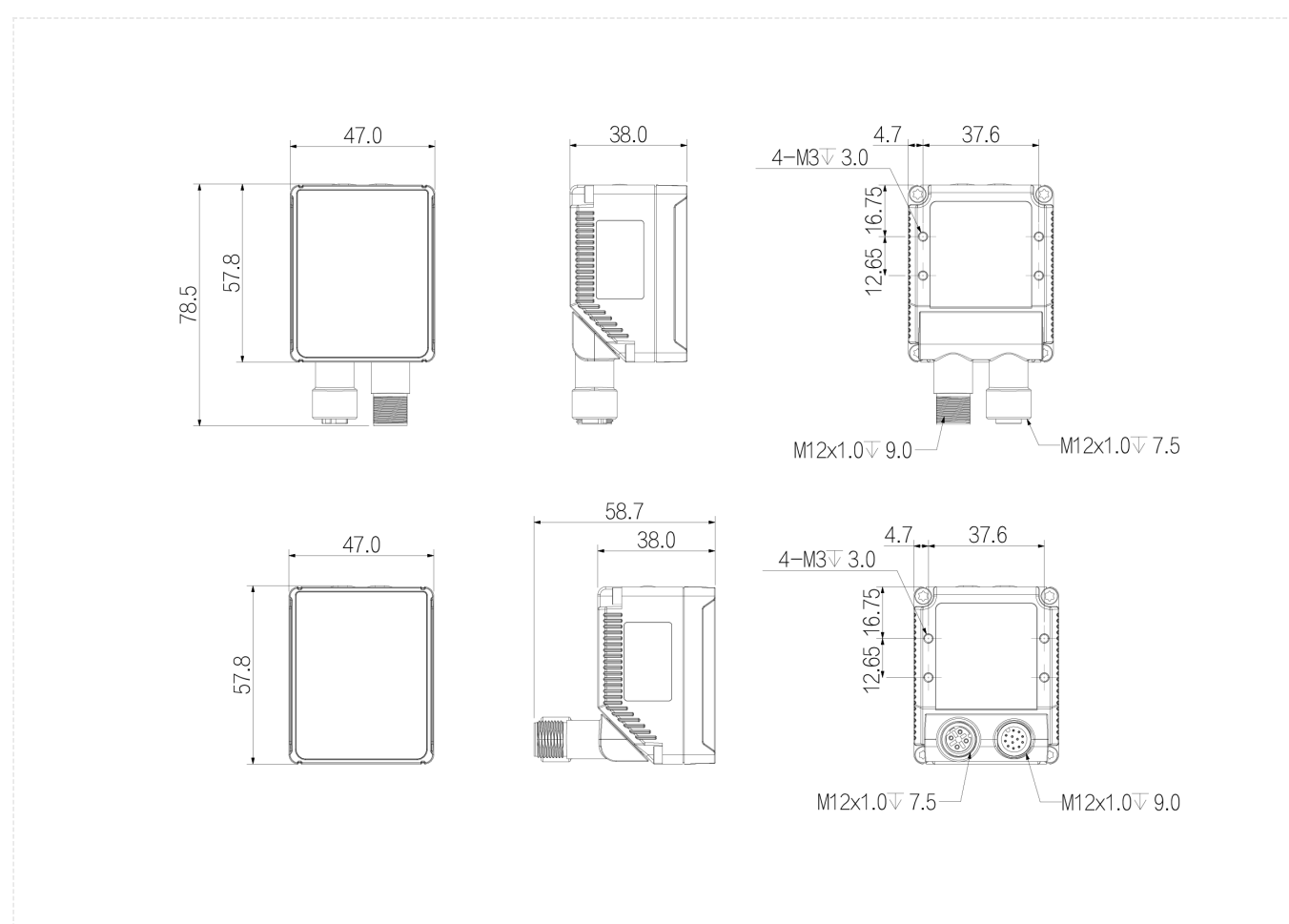













Specification

	Model	SS4013MG-12M-WGN01E
Basic	Resolution	1280 × 1024
	Max. Frame rate	60 fps
	Shutter Mode	Global
	Mono/Color	Mono
	Lens Mount	M12, auto focus
	Trigger Mode	Software/external/free run etc.
	Software	EasyVS
	Certifications	CE, KC
	Function	AI Tool: Classification Positioning: pattern match, line match, circle match; Inspection : profile contrast, pixel counting, brightness , contrast; Identification : 1 dimensional and 2 dimensional codes ; Logic Tool: mathematical logic operation
	Focal Length	12 mm
	Focus Control	Auto focus
Light Source Type	White (Red & Blue options) , 1-channel diffused and 2- channel transparent light	
Performance	Working Distance	50-500mm
	Field of View	64×51 mm @150mm
Port	Connector	2 industrial M12 connectors, Ethernet and GPIO
	Network Port	100M Ethernet
	GPIO Interface	RS232, 2 Opto-isolated inputs, 3 Opto-isolated outputs
	Communication Mode	RS232, Ethernet
	Communication protocol	TCP Client,TCP Server,UDP,FTP,RS232,Profinet,EtherNet/IP
	LED Indicator	Power, Ethernet, Result
Power	Power Supply	Support 9~26VDC, 1.5A input
	Power Consumption	<14W
Structure	Product Dimensions	47mm×58mm×38mm (excluding connectors)
	Net Weight	<180 g
	Protection	IP65
	Casing Material	Aluminum alloy (excluding front cover)
Environment	Operating Temperature	-20°C ~ +50°C
	Operating Humidity	20% ~ 95%, non-condensing
	Storage Temperature	-30°C ~ +70°C

Connector Pin-out

12 pin-out on camera:

Pin	Signal	Description	Cable Color
1	OPT_OUT2	Opto-isolated output2	 Brown white
2	RS232_TXD	RS232 serial send	 Grey
3	RS232_RXD	RS232 serial receive	 Purple
4	SIGNAL_GND	RS232 serial GND	 Black white
5	OPT_IN1	Opto-isolated input1	 Yellow
6	OPT_IN_GND	Opto-isolated input GND	 Purple white
7	POWER	Power	 Red
8	POWER_GND	Power GND	 Black
9	OPT_OUT_GND	Opto-isolated output GND	 Green
10	OPT_IN0	Opto-isolated input0	 Orange
11	OPT_OUT0	Opto-isolated output0	 Blue
12	OPT_OUT1	Opto-isolated output1	 Brown
-	-	Shield GND	 White

